



16

OCCURRENCE AND EXTRACTION OF METALS

Metals and their alloys are extensively used in our day-to-day life. They are used for making machines, railways, motor vehicles, bridges, buildings, agricultural tools, aircrafts, ships etc. Therefore, production of a variety of metals in large quantities is necessary for the economic growth of a country. Only a few metals such as gold, silver, mercury etc. occur in free state in nature. Most of the other metals, however, occur in the earth's crust in the combined form, i.e., as compounds with different anions such as oxides, sulphides, halides etc. In view of this, the study of recovery of metals from their ores is very important. In this lesson, you shall learn about some of the processes of extraction of metals from their ores, called metallurgical processes.



OBJECTIVES

After reading this lesson, you will be able to :

- differentiate between minerals and ores;
- recall the occurrence of metals in native form and in combined form as oxides, sulphides, carbonates and chlorides;
- list the names and formulae of some common ores of Na, Al, Sn, Pb, Ti, Fe, Cu, Ag and Zn;
- list the occurrence of minerals of different metals in India;
- list different steps involved in the extraction of metals;

* An alloy is a material consisting of two or more metals, or a metal and a non-metal. For example, brass is an alloy of copper and zinc; steel is an alloy of iron and carbon.



Notes

- list and explain various methods for concentration of ores (gravity separation, magnetic separation, froth floatation and chemical method);
- explain different metallurgical operations : roasting, calcination and smelting with suitable examples;
- choose the reducing agent for a given ore;
- differentiate between flux and slag, and
- explain different methods for refining of metals : poling, liquation, distillation and electrolytic refining.
- explain the process involved in the extraction of Al, Fe, Cu, and Zn.

16.1 OCCURRENCE OF METALS

Metals occur in nature in free as well as combined form. Metals having low reactivity show little affinity for air, moisture, carbon dioxide or other non-metals present in nature. Such metals may remain in elemental or native (free) state in nature. Such metals are called "noble metals" as they show the least chemical reactivity. For example gold, silver, mercury and platinum occur in free state.

On the other hand, most of the metals are active and combine with air, moisture, carbon dioxide and non-metals like oxygen, sulphur, halogens, etc. to form their compounds, like oxides, sulphides, carbonates, halides and silicates. i.e., they occur in nature in a combined state.

A naturally occurring material in which a metal or its compound occurs is called a *mineral*. A mineral from which a metal can be extracted economically is called an *ore*.

An ore is that mineral in which a metal is present in appreciable quantities and from which the metal can be extracted economically.

The main active substances present in nature, especially in the atmosphere are oxygen and carbon dioxide. In the earth's crust, sulphur and silicon are found in large quantities. Sea-water contains large quantities of chloride ions (obtained from dissolved sodium chloride). Most active metals are highly electropositive and therefore exist as ions. It is for this reason that most of the important *ores* of these metals occur as (i) oxides (ii) sulphides (iii) carbonates (iv) halides and (v) silicates. Some sulphide ores undergo oxidation by air to form sulphates. This explains the occurrence of sulphate ores.

Ores are invariably found in nature in contact with rocky materials. These rocky or earthy impurities accompanying the ores are termed as *gangue* or *matrix*.

Some important ores and the metals present in these ores are listed in Table 16.1

Table 16.1: Some Important Ores

| Type of Ore | Metals (Common Ores) |
|----------------|---|
| Native Metals | Gold (Au), silver (Ag) |
| Oxide ores | Iron (Haematite, Fe_2O_3); Aluminium (Bauxite, $Al_2O_3 \cdot 2H_2O$); Tin (Cassiterite, SnO_2); Copper (Cuprite, Cu_2O); Zinc (Zincite, ZnO); Titanium (Ilmenite, $FeTiO_3$, Rutile, TiO_2) |
| Sulphide ores | Zinc (Zinc blende, ZnS); Lead (Galena, PbS); Copper (Copper glance, Cu_2S); Silver (Silver glance or Argentite, Ag_2S); Iron (Iron pyrites, FeS_2) |
| Carbonate ores | Iron (Siferite, $FeCO_3$); Zinc (Calamine, $ZnCO_3$), Lead (Cerrusite, $PbCO_3$) |
| Sulphate ores | Lead (Anglesite, $PbSO_4$) |
| Halide ores | Silver (Horn silver, $AgCl$); Sodium (Common salt or Rock salt, $NaCl$); Aluminium (Cryolite, Na_3AlF_6) |
| Silicate ores | Zinc (Hemimorphite, $2ZnO \cdot SiO_2 \cdot H_2O$) |



Notes

16.1.1 Mineral Wealth of India

India possesses large deposits of minerals of some important metals such as iron, manganese, aluminium, magnesium, chromium, thorium, uranium, titanium and lithium. They constitute one-quarter of the world's known mineral resources. Mineral fuels (like coal, petroleum and natural gas) constitute more than 80% while metallic minerals constitute only about 10% of the total volume of mineral production in a year. In this section, we shall list some of the important minerals of a few common metals such as Fe, Cu, Ag, Zn, Ti, Al, Sn, Pb and Na and their locations in India.

Important Ores of Some Common Elements

| | |
|------------------|---|
| <i>Iron</i> | Iron ore reserves in the country are estimated at 1750 crore tonnes. Major iron ore mining is done in Goa, Madhya Pradesh, Bihar, Karnataka, Orissa and Maharashtra. |
| <i>Aluminium</i> | Its chief ore, bauxite is available in India in abundance. The annual production of bauxite is estimated to be more than 2 million tonnes. Important deposits of bauxite in the country occur in Bihar, Goa, Madhya Pradesh, Maharashtra, Tamil Nadu, Gujarat, Karnataka, Orissa, Uttar Pradesh, Andhra Pradesh, Jammu & Kashmir and Rajasthan. |



Notes

| | |
|----------------------|--|
| <i>Copper</i> | India does not have rich copper ore deposits. The total reserves of the ore in the country are estimated around 60 crore tonnes. Major ore producing areas are Singhbhum district (Bihar), Balaghat district (Madhya Pradesh) and Jhunjhunu district (Rajasthan). |
| <i>Zinc and Lead</i> | India has no significant deposits of lead ores. Lead and Zinc have been located at Zawar mines near Udaipur (Rajasthan) and at Hazaribagh (Jharkhand), Sargipalli mines in Orissa and Bandalamottu lead project in Andhra Pradesh. Some reserves have been located in Gujarat and Sikkim. The total reserves are estimated at about 360 million tonnes in which lead content is estimated to be around 5 million tonnes and zinc to be around 16 million tonnes. |
| <i>Tin</i> | Deposits of tinstone (SnO_2) are found in Hazaribagh (Jharkhand) and Orissa. |
| <i>Silver</i> | India does not possess rich silver deposits. Gold from Kolar fields and Hutti gold fields (Karnataka) and lead-zinc ores of Zawar mines (Rajasthan) contain some silver. |
| <i>Titanium</i> | Ilmenite (FeTiO_3) is recovered from beach sands of Kerala and Tamil Nadu. The estimated reserves are around 100 to 150 million tonnes. |
| <i>Sodium :</i> | Tincal or Native borax ($\text{Na}_2\text{B}_4\text{O}_7 \cdot 10\text{H}_2\text{O}$) is found in Ladakh and Kashmir. |

16.2 GENERAL PRINCIPLES OF EXTRACTION OF METALS

The process of extracting the metals from their ores and refining them is called *metallurgy*. The choice of the process depends upon the nature of the ore and the type of the metal. The metal content in the ore can vary depending upon the impurities present and chemical composition of the ore. Some common steps involved in the extraction of metals from their ores are :

- (i) Crushing and pulverization
- (ii) Concentration or dressing of the ore
- (iii) Calcination or roasting of the ore
- (iv) Reduction of metal oxides to free metal
- (v) Purification and refining of metal.

16.2.1. Crushing and Pulverization

The ore is generally obtained as big rock pieces. These big lumps of the ore are crushed to smaller pieces by using *jaw-crushers* and *grinders*. It is easier to work with crushed ore. The big lumps of the ore are brought in between the plates of a

crusher forming a jaw. One of the plates of the crusher is stationary while the other moves to and fro and the crushed pieces are collected below (Fig. 16.1).

The crushed pieces of the ore are then pulverized (powdered) in a stamp mill shown in Fig. 16.2. The heavy stamp rises and falls on a hard die to powder the ore. The powdered ore is then taken out through a screen by a stream of water. Pulverization can also be carried out in a ball mill. The crushed ore is taken in a steel cylinder containing iron balls. The cylinder is set into revolving motion. The striking balls pulverize the crushed ore into fine powder.

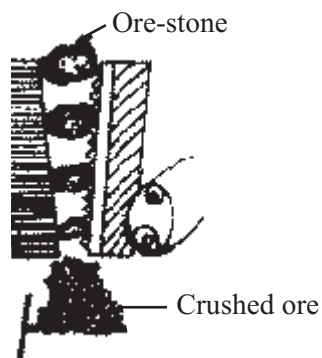

Fig. 16.1 : Jaw Crusher

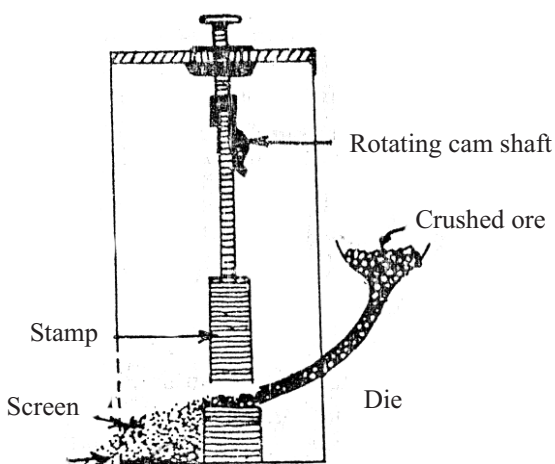

Fig. 16.2 : The Stamp mill

16.2.2 Concentration or Dressing of the Ore

Generally, the ores are found mixed with earthy impurities like sand, clay, lime stone etc. These unwanted impurities in the ore are called *gangue* or *matrix*.

The process of removal of gangue from powdered ore is called concentration or ore dressing.

There are several methods for concentrating the ores. The choice of method depends on the nature of the ore. Some important methods are :

- (i) **Gravity separation (Hydraulic washing)** : In this method, the light (low specific gravity) earthy impurities are removed from the heavier metallic ore particles by washing with water. It is therefore, used for the concentration of heavier oxide ores, like haematite (Fe_2O_3) tinstone (SnO_2) and gold (Au). In this method, as shown in the Fig. 16.3 the powdered ore is agitated with



Notes



Notes

water or washed with a strong current of water. The heavier ore settles down rapidly in the grooves and the lighter sandy and earthy materials (gangue particles) are washed away.

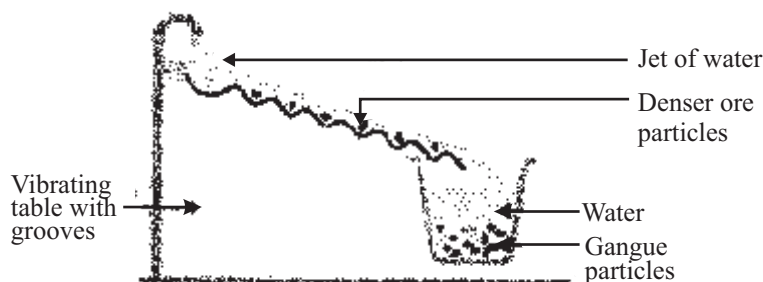

Fig. 16.3 : Gravity Separation (Hydraulic Washing)

(ii) Magnetic separation method :

By this method, those ores can be concentrated which either contain impurities which are magnetic or are themselves magnetic in nature.

For example, the tin ore, tin stone (SnO_2) itself is non-magnetic but contains magnetic impurities such as iron tungstate (FeWO_4) and manganese tungstate (MnWO_4).

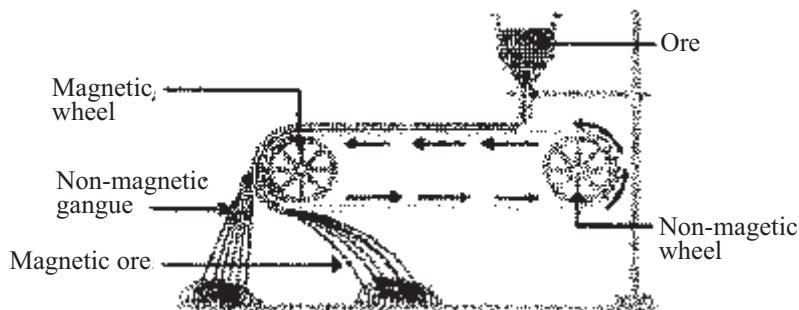

Fig. 16.4. : Magnetic Separation

The finely powdered ore is passed over a conveyer belt moving over two rollers, one of which is fitted with an electromagnet (Fig. 16.4). The magnetic material is attracted by the magnet and falls in a separate heap. In this way magnetic impurities are separated from non-magnetic material.

(iii) Froth floatation method :

This method is especially applied to sulphide ores, such as **galena** (PbS), **zinc blende** (ZnS), or **copper pyrites** (CuFeS_2). It is based on the different wetting properties of the surface of the ore and gangue particles. The sulphide ore particles are wetted preferentially by oil and gangue particles by water. In this process, finely powdered ore is mixed with either pine oil or eucalyptus oil. It is then mixed with water. Air is blown through the mixture with a great force. Froth is produced in this process which carries the wetted ore upwards with it. Impurities (gangue particles) are left in water and sink to the bottom from which these are drawn off (Fig. 16.5).

(iv) Chemical method :

In this method the ore is treated with a suitable chemical reagent which dissolves the ore leaving behind insoluble impurities. The ore is then recovered from the solution by a suitable chemical method. This is applied for extraction of aluminium from bauxite ($\text{Al}_2\text{O}_3 \cdot 2\text{H}_2\text{O}$).

Bauxite is contaminated with iron (III) oxide (Fe_2O_3), titanium (IV) oxide (TiO_2) and silica (SiO_2). These impurities are removed by digesting the powdered ore with aqueous solution of sodium hydroxide at 420 K under pressure. Aluminium oxide dissolves in sodium hydroxide, whereas, iron (III) oxide, silica and titanium (IV) oxide remain insoluble and are removed by filtration.

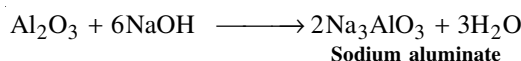

Sodium aluminate is diluted with water to obtain precipitate of aluminium hydroxide. It is filtered and ignited to obtain pure alumina.

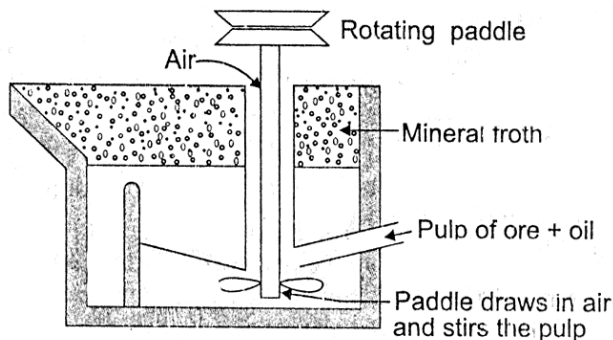
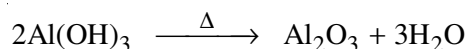
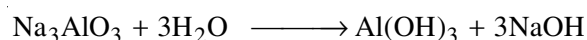

Enlarged view of an air bubble showing mineral particles attached to it

Fig. 18.5 : Froth floatation

Notes

INTEXT QUESTIONS 16.1

- Write the names of eight important metals. Give an example of one important ore of each metal.
- What is the difference between an ore and a mineral?
- Name some important methods of concentrating the ores.
- Which method of concentration is applied in the following cases?

| | | |
|-------------------|--------------------|-------------------|
| (i) Magnetic ores | (ii) Sulphide ores | (iii) Bauxite ore |
|-------------------|--------------------|-------------------|
- Which metal is extracted from the mineral zinc blende ?



Notes

16.2.3 Calcination and Roasting of the Ore

The concentrated ore is converted into metal oxide by calcination or roasting.

(A) Calcination :

Calcination involves heating of the concentrated ore in a limited supply of air so that it loses moisture, water of hydration and gaseous volatile substances. The ore is heated to a temperature so that it does not melt. Two examples of calcination are given below:

(i) Removal of water of hydration

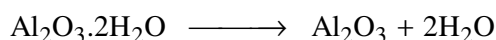

(ii) Expulsion of CO_2 from carbonate

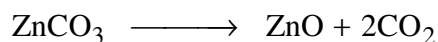

(B) Roasting :

Roasting is a process in which the concentrated ore is heated in a free supply of air at a temperature insufficient to melt it. The following changes take place during roasting :

(i) Drying of the ore.

(ii) Removal of the volatile impurities like arsenic, sulphur, phosphorus and organic matter.

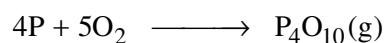
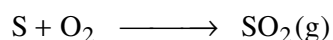
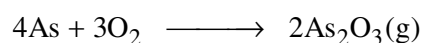

(iii) Conversion of the sulphide ores into oxides

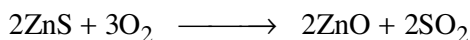
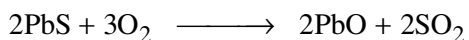

Calcination and roasting are generally carried out in a reverberatory furnace or in a multiple hearth furnace.

16.2.4 Reduction of the Metal Oxides to Free Metal

This process is carried out after calcination or roasting of ores. In this process called *smelting*, the oxide ores are converted into the metallic state by reduction.

(A) Smelting :

Smelting is a process in which the oxide ore in molten state is reduced by carbon or other reducing agents to free metal.



Notes

(i) *By using carbon as a reducing agent :*

This method is used for the isolation of iron, tin and zinc metals from their respective oxides. The oxide ores are strongly heated with charcoal or coke. Reduction occurs by the action of carbon and/or carbon monoxide which is produced by the partial combustion of coke or charcoal.

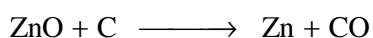
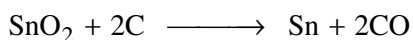
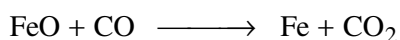
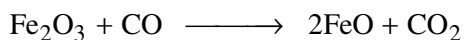
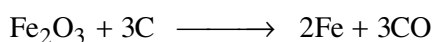

Although the ore has been concentrated in an earlier step, it is still contaminated with some gangue material which is finally removed in the reduction process by the addition of *flux* during smelting.

Flux is a chemical substance which combines with gangue at higher temperatures to form easily fusible material called *slag* which is not soluble in the molten metal. Flux are of two types :

Basic Flux :

On heating, lime stone is converted into calcium oxide used as basic flux which combines with acidic impurities like silica in metallurgy of iron and forms fusible calcium silicate (CaSiO_3).

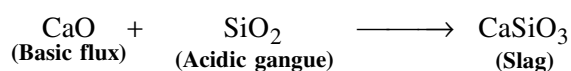
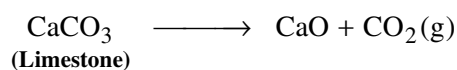
*Acidic flux :*

SiO_2 is used as acidic flux to remove basic impurity of FeO in metallurgy of Cu.



The fusible slag, such as calcium silicate formed during smelting floats over the molten metal and is thus easily removed. Another advantage is that the slag provides a covering to the molten metal thus preventing it from getting oxidized by air.

(ii) *Other reducing agents :*

Oxide ores which cannot be reduced by carbon or metals which show affinity to carbon by forming metal carbides, are reduced by reducing agents like



Notes

aluminium, sodium, magnesium or hydrogen. *Oxide* like chromium oxide (Cr_2O_3) or manganese oxide (Mn_3O_4) are reduced by aluminium powder is a highly exothermic reaction. This process is known as *Goldschmidt's Alumino-thermite reduction method*.

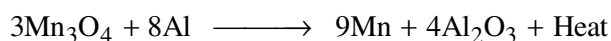
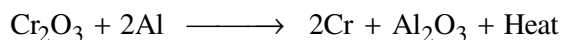

Heat is generated in the process due to the formation of Al_2O_3 which is a highly exothermic reaction.

Titanium is obtained by the reduction of TiCl_4 (produced by the action of carbon and chlorine on TiO_2) by Mg in an inert atmosphere of argon (Kroll process).

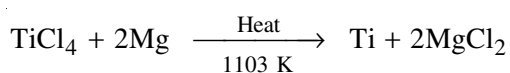

Titanium can also be obtained by the reduction of TiO_2 by sodium

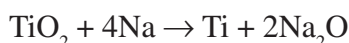

Tungsten and molybdenum can be obtained by the reduction of their oxides by hydrogen,

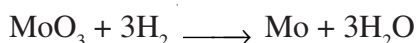

(iii) Self-reduction :

This is applied to the sulphide ores of copper, mercury and lead. The ores are heated in air, a part of these sulphide ores is changed into the oxide or sulphate which then reacts with the remaining part of the sulphide ore to give the metal and sulphur dioxide. The reactions showing their extraction are given below :

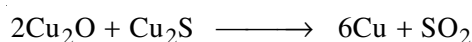
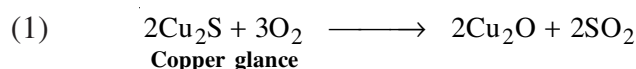

Copper produced at this stage is called *Blister copper*. The evolution of sulphur dioxide produces blisters on the surface of solidified copper metal.

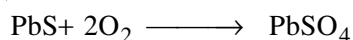
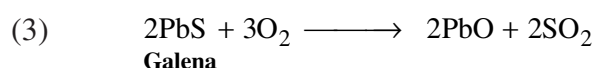
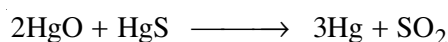
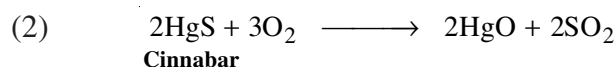

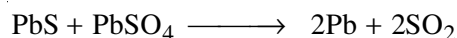
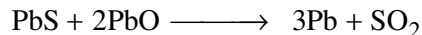
**(B) Reduction of concentrated ores by other methods:**

Some metals cannot be obtained from their ores by using common reducing agents such as C, CO, H₂ etc. Other methods of reduction are used for such cases.

(i) Reduction by precipitation :

Noble metals like silver and gold are extracted from their concentrated ores by dissolving metal ions in the form of their soluble complexes. The metal ions are then regenerated by adding a suitable reagent. For example, concentrated argentite ore (Ag₂S) is treated with a dilute solution of sodium cyanide (NaCN) to form a soluble complex :

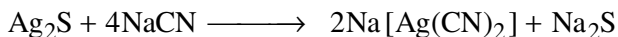

This solution is decanted off and treated with zinc to precipitate silver,

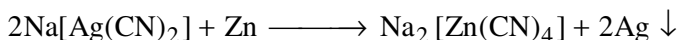
**(ii) Electrolytic Reduction :**

Active metals like sodium, potassium and aluminium etc., are extracted by the electrolysis of their fused (*molten*) salts. For example, sodium is obtained by the electrolysis of fused sodium chloride (Down's process). The reactions taking place in the electrolytic cell are :

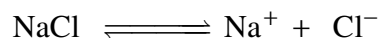

Na⁺ ions move towards the cathode and Cl⁻ ions move towards the anode. Following reactions take place at the electrodes :

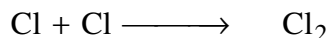
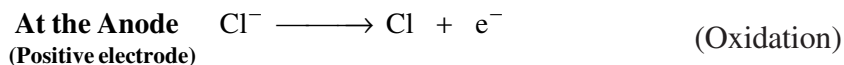
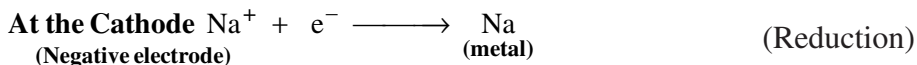

Aluminium is extracted from molten alumina (Al₂O₃) by electrolysis. The melting point of alumina is quite high (2323K) which is inconvenient for electrolysis. It dissolves in molten cryolite (Na₃AlF₆) at around 1273 k. The reactions which take place in the cell are:

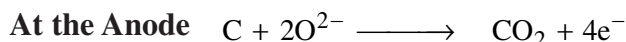
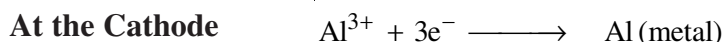

Notes



Notes

INTEXT QUESTIONS 16.2

1. Explain the following terms :
Calcination, Roasting, Smelting, Flux and Slag.
2. Which is the cheapest and most abundant reducing agent employed in the extraction of metals ?
3. Name the process which is used for converting sulphide ores into oxides.
4. How are oxide ores reduced ?
5. Name few materials which are used as flux in metallurgical processes.
6. What happens to (i) Bauxite and (ii) Calamine ores during calcination ?

16.2.5 Refining of Metals

Except in the electrolytic reduction method, metals produced by any other method are generally impure. The impurities may be in the form of (i) other metals (ii) unreduced oxide of the metal (iii) non-metals like carbon, silicon, phosphorus, sulphur etc. and (iv) flux or slag. Crude metal may be refined by using one or more of the following methods :

- (i) *Liquation* : Easily fusible metals like tin, lead etc. are refined by this process. In this method, the impure metal is poured on the sloping hearth of a reverberatory furnace (Fig.16.6) and heated slowly to a temperature little above the melting point of the metal. The pure metal drains out leaving behind infusible impurities.



Fig. 16.6 : Liquation

- (ii) *Poling* : Poling involves stirring the impure molten metal with green logs or bamboo. The hydrocarbons contained in the pole reduce any metal oxide present as impurity. Copper and tin are refined by this method (Fig. 16.7).
- (iii) *Distillation* : Volatile metals like zinc and mercury are purified by distillation. The pure metal distils over, leaving behind non-volatile impurities.

(iv) *Electrolytic Refining* : A large number of metals like copper, silver, zinc, tin etc. are refined by electrolysis. A block of impure metal is made the anode and a thin sheet of pure metal forms the cathode of the electrolytic cell containing suitable metal salt solution which acts as an electrolyte (Fig. 16.8). On passing current, pure metal deposits at the cathode sheet while more electropositive impurities are left in solution. Less electropositive metals do not dissolve and fall away from the anode to settle below it as *anode mud*.

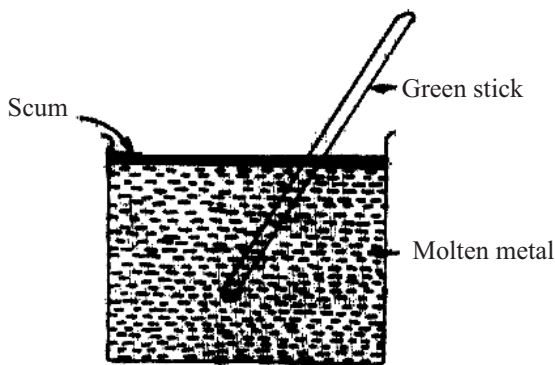

Fig. 18.7 : Polling

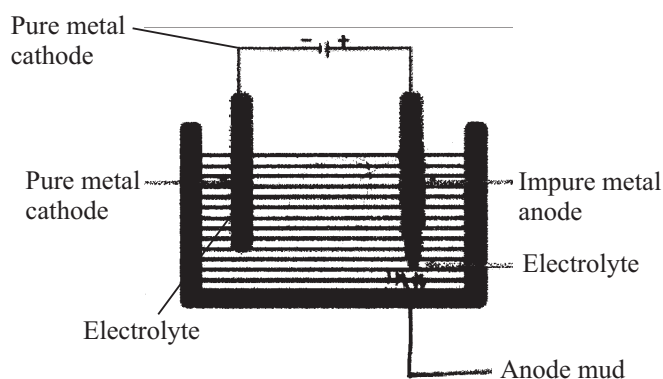
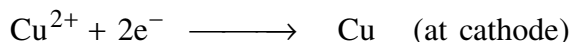
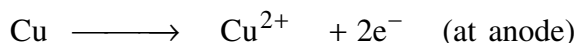

Fig. 16.8 : Electrolytic Refining

For example, in the electrolytic refining of crude copper (blister copper), a large piece of impure copper is made anode and a thin piece of pure copper is made the cathode. An acidified solution of copper sulphate is used as an electrolyte. On passing an electric current of low voltage through the solution copper (II) ions obtained from copper sulphate solution go to the cathode where they are reduced to the free copper metal and get deposited.



An equivalent amount of the metal from the anode dissolves into the electrolyte as Cu^{2+} ions



As the process goes on, anode becomes thinner while the cathode becomes thicker. The impurities like silver, gold settle down at the bottom of the cell as '*anode mud*'.



Notes

16.3 EXTRACTION OF Al, Fe, Cu AND Zn

Aluminium

Extraction of Aluminium

Aluminium is the most abundant metallic element in the earth's crust, occurring in a variety of aluminosilicates such as clay, micas and feldspars. The only ore of aluminium from which it is profitable to extract the metal is bauxite.

The bauxite is first freed from silica and iron (III) oxide impurities by dissolving it in sodium hydroxide (iron(III) oxide remains undissolved) and then precipitating aluminium hydroxide by seeding the solution with a little aluminium hydroxide (silica remains dissolved):

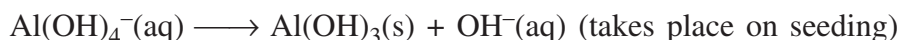
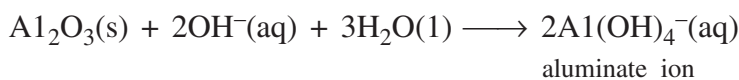

Pure aluminium oxide is now obtained by heating the hydroxide:



It is dissolved in molten cryolite, $(\text{Na}^+)_3\text{AlF}_6^{3-}$, and electrolysed at about 900°C, using a number of graphite blocks as anodes and a graphite lined bath as the cathode. Aluminium is discharged at the cathode and collects at the bottom of the molten electrolyte as a liquid, from where it can be tapped off and allowed to solidify. Oxygen is evolved at the anodes, which are slowly burnt away as carbon dioxide.

The extraction of aluminium is only economic where cheap electricity is available from water power. A low voltage is used to avoid decomposing the molten cryolite which acts as a solvent; a very high current density is used. One theory assumes that aluminium oxide dissociates into Al^{3+} and AlO_3^{3-}



Cathode

Anode

Al^{3+} discharged

AlO_3^{3-} discharged

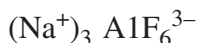
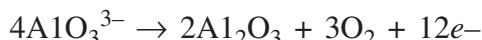

Molten cryolite solvent

The process, however, is probably much more complex.

Iron

Iron, which is the second most abundant metal occurring in the earth's crust, is extracted from its oxides, haematite, Fe_2O_3 , and magnetite, Fe_3O_4 , and also



Notes

from the carbonate siderite, FeCO_3 . Iron pyrites, FeS_2 , is not considered to be an important ore of iron.

The extraction of iron is carried out in a blast furnace which can vary in size and can be between 25 and 60 metres in height and up to 10 metres in diameter. It is constructed from steel with the inner regions lined with firebricks. A charge of iron ore, limestone and coke in the correct proportions is fed into the top of the furnace through a cone and hopper arrangement. Preheated air at a temperature of about 600°C is injected into the furnace through a number of pipes called tuyeres; the tuyeres are fed from a 'bustle' pipe encircling the blast furnace. The blast furnace is provided with two tap holes which are plugged with clay; molten iron is tapped from the lower one and molten slag from the other. The production of iron is a continuous process and, depending upon its size, a blast furnace can produce from 1000 to 1800 tonnes of iron every twenty-four hours.



Notes

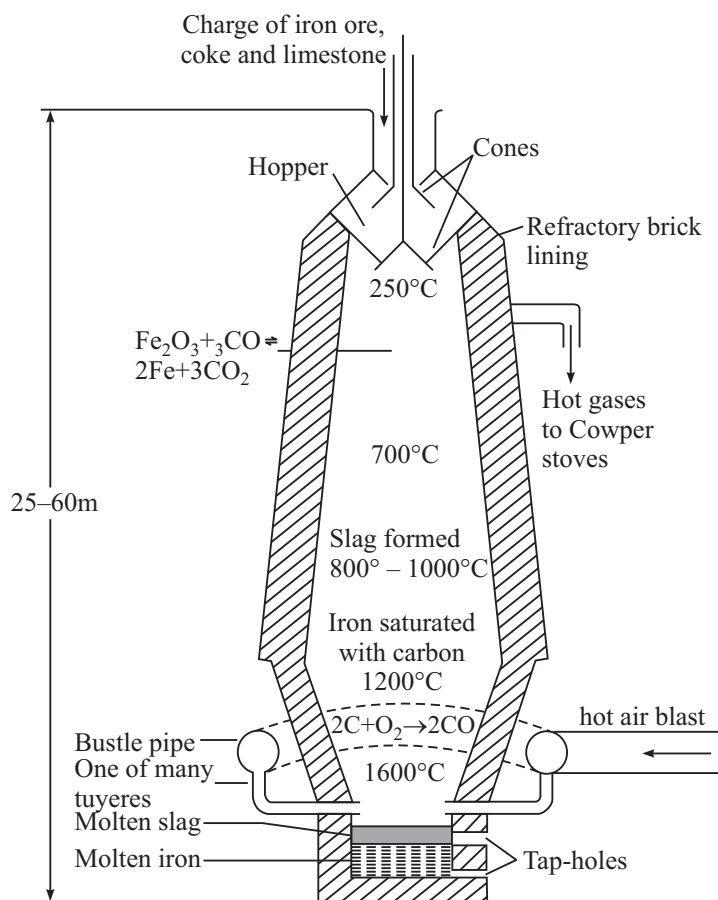

The energy and reducing agent required for the smelting of iron are obtained by the combustion of coke, the temperature of the charge increasing steadily as it falls through the ascending combustion gases:

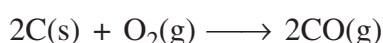



Notes

At a temperature of about 700°C the iron ore is reduced to spongy iron by the carbon monoxide:

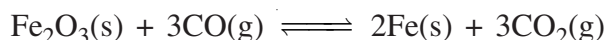

Since this reaction is reversible a high CO/CO₂ pressure ratio favours the reduction to iron.

The limestone decomposes at about 800°C and the calcium oxide reacts with sandy impurities to form a slag of calcium silicate. More carbon monoxide is produced by the reduction of carbon dioxide:

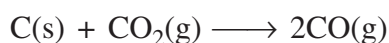
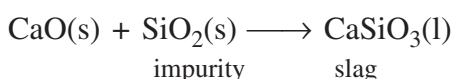

The reduction of the iron oxide is completed by the coke at a temperature in the region of 1200°C and cementite, Fe₃C, and graphite enter the iron. Other reactions also occur at high temperatures, for instance silica is reduced to silicon and this enters the iron as ferrosilicon:

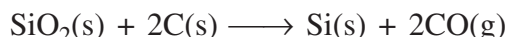

The molten metal is either run out into moulds of sand, when it is known as pig-iron, or more generally conveyed directly in the liquid form to steelmaking plants. The slag is tapped from the furnace as a liquid and can be used in concrete or blown into a ‘woolly’ material and used for insulation.

The hot gases emerging from the top of the furnace contain appreciable amounts of carbon monoxide and are burnt in Cowper stoves to preheat the air for the blast.

Cast iron

Iron castings are made by igniting a mixture of pig-iron, scrap iron and coke in cupola furnaces by a blast of hot air. The molten iron is poured into moulds to make articles such as manhole covers, guttering, machinery frames and drainpipes. Cast iron expands slightly on solidifying and therefore faithfully reproduces the shape of the mould. It is extremely hard, but unfortunately is very brittle and will fracture if struck by a sharp blow. The impurities in cast iron lower the melting point from 1535°C for pure iron to approximately 1200°C.

Wrought iron

This is made by heating impure iron with haematite so that impurities are oxidised. Carbon is converted to carbon monoxide and silicon and manganese to a slag.



As the impurities are removed, the melting point of the iron rises to about 1500°C and the pasty mass is removed from the furnace as balls and worked under a hammer to squeeze out the slag. Wrought iron is tough, malleable and ductile; it can be worked by a blacksmith into chains, railway carriage couplings and ornamental gates, etc.



Notes

Copper

Although copper does not occur abundantly in nature, many copper-containing ores are known. It is principally extracted from copper pyrites, CuFeS_2 , copper glance, Cu_2S , and cuprite, Cu_2O . The extraction of copper from copper pyrites will be considered.

The pulverized ore is concentrated by the froth flotation process and roasted in a limited supply of air to convert the iron into iron (II) oxide :



After the addition of silica, SiO_2 , the mixture is heated in the absence of air to convert the iron (II) oxide into a slag of iron (II) silicate, FeSiO_3 ,

which is poured away. The copper (I) sulphide is now reduced to copper by heating in a controlled amount of air:



Zinc

Zinc is usually extracted from its ore zinc blende, ZnS and calamine ZnCO_3 . The zinc ores are first concentrated and then roasted in air to convert them into the oxide:

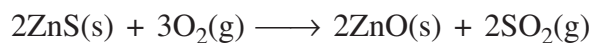

The sulphur dioxide produced is used to manufacture sulphuric acid. The zinc oxide is mixed with powdered coke and heated to 1400°C. Zinc oxide is reduced by the coke and the mixture of zinc vapour and carbon monoxide pass through an outlet near the top of the retort:

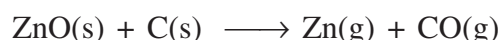

Liquid zinc is run out into moulds and solidifies. The hot carbon monoxide is used to preheat the briquettes.



Notes



INTEXT QUESTIONS 16.3

1. State the nature of materials used for constructing cathodes and anodes in the electrolytic cell for refining of copper. Write chemical equations for the reactions which take place.
2. Which method is used for the refining of metals that are easily fused ?
3. Which metals are refined by poling ?
4. Name a metal which is purified by distillation.
5. Name any three elements which are refined by electrolytic refining.
6. What is role of cryolyte in the extraction of Al.
7. Which one is responsible to reduce Fe_2O_3 to Fe C or CO.



WHAT YOU HAVE LEARNT

- Metals play an extremely useful role in day-to-day life.
- Most metals are found in nature in combined form. Only a few noble metals such as gold, silver, occur in nature in free state,
- The process of extraction of metals from their ores is called *metallurgical process*.
- A naturally occurring material in which a metal or its compound occurs is called a mineral. A mineral from which a metal can be extracted economically is called an ore. Thus all minerals do not serve the purpose of ores.
- Most active metals are highly electropositive and exist as M^{n+} ions. Therefore, they are found in nature in association with some common anions, i.e., as salts like *oxides, sulphides, carbonates, halides, silicates* etc. Some sulphides slowly undergo oxidation by air to form *sulphates*.
- India possesses rich mineral wealth with abundance of iron, aluminium and some amount of copper, tin, lead, silver and gold.
- Various steps involved in the extraction of metal are :
 - (i) Crushing and pulverization
 - (ii) Concentration or dressing of the ore
 - (iii) Calcination or Raosting of the concentrated ore
 - (iv) Reduction of the oxides to free metal
- The metals thus obtained are then purified by employing some suitable method, viz. *liquation, poling, distillation or electrolytic refining*.
- Metallurgical operations involved in the extraction of Fe, Al, Cu & Zn.



TERMINAL EXERCISE

- Name the metal oxides that are not reduced to metallic state by heating with carbon. Which reducing agent is used for these ores ?
- Which metal sulphide combines with its oxide to form metal ? Give reactions.
- Name four reducing agents other than carbon, used during smelting.
- What is the difference between calcination and roasting ?
- Give the name and formula of at least one ore, of the following metals :
(i) copper (ii) zinc (iii) iron (iv) tin
- What happens when
(i) Calamine is calcined.
(ii) Zinc blende is roasted.
(iii) Silica is heated with lime stone.
- Describe the froth floatation method for the concentration of sulphide ore.
- Give chemical equations involved in the self reduction method for the extraction of copper.
- How will you obtain iron from its ore?
- Explain the process involved in the extraction of Al from $\text{Al}_2\text{O}_3 \cdot 2\text{H}_2\text{O}$.



Notes



ANSWERS TO INTEXT QUESTIONS

16.1

- Sodium (Na), Aluminium (Al), Silver (Ag), Iron (Fe), Zinc (Zn), Lead (Pb), Gold (Au), Mercury (Hg).
Ores : rock salt, bauxite, argentite, haematite, zincite, galena, native gold, cinnabar, respectively.
- Mineral* is a naturally occurring material in which a metal or its compound occurs.
An *ore* is that mineral in which metal is present in large quantity and from which the metal can be extracted in pure and high quality, economically.
- Gravity separation, magnetic separation, froth floatation and chemical method.
- (i) Magnetic separation method
(ii) Froth floatation method
(iii) Chemical method
- Zinc.



Notes

16.2

1. *Calcination* : it involves heating of the ore in a limited supply of air to a temperature that the ore does not melt.

Roasting : It involves heating of the ore in a free supply of air to a temperature that the ore does not melt.

Smelting : The extraction of metal in the fused state is termed smelting. The ore is reduced by carbon to the free metal.

Flux : it is a chemical substance which combines with gangue at higher temperatures to form easily fusible material called slag.

Slag is a fusible chemical compound formed by the reaction of flux with gangue. Slag is not soluble in the molten metal and is thus separated.

2. Carbon in the form of coke.

3. Roasting ; $2\text{ZnS} + 3\text{O}_2 \longrightarrow 2\text{ZnO} + 2\text{SO}_2(\text{g})$

4. Oxide ores are reduced to metal by heating them with coke.

5. Silica, borax and other non-metallic oxides are acidic fluxes. Lime stone (CaCO_3) is a basic flux.

6. (i) $\text{Al}_2\text{O}_3 \cdot 2\text{H}_2\text{O} \longrightarrow \text{Al}_2\text{O}_3 + 2\text{H}_2\text{O}$

(ii) $\text{ZnCO}_3 \longrightarrow \text{ZnO} + \text{CO}_2$

16.3

1. Cathode : Pure metal At Cathode : $\text{Cu}^{2+} + 2\text{e} \rightarrow \text{Cu}$

Anode : Impure metal At Anode : $\text{Cu} \rightarrow \text{Cu}^{2+} + 2\text{e}$

2. Liquation

3. Copper and tin

4. Zinc

5. Copper, Silver and Tin

6. (i) decrease the melting point of alumino

(ii) To increase the conductance

7. CO