

**25**

INSERTING IMAGES AND LISTS IN A WEB PAGE

In the previous lesson you have learnt how to create web pages with formatted text. You know that web pages also contain images. Images make a web page more colorful and interesting. If a web page contains text only then most of the people may not like to read it completely. A page becomes more interesting and attractive if it contains images to illustrate some concepts or just to show the images of some events or personalities. In this lesson you will learn how to insert images in a web page.



OBJECTIVES

After reading this lesson, you will be able to:

- identify image files by their file name extension;
- insert images in a web page;
- format images and text on a web page.

25.1 IMAGE FORMATS

Digital images exist in many different formats like JPEG, GIF, Exif, TIFF, RIF, PNG, BMP, and many more. Each of these file formats has its own pros and cons. For the web pages, best suited file formats are JPG, GIF, and PNG.

- JPG file format is the best option for images with lots of colors such as photographs. Their file size is also small and can be further reduced to suit the requirements.

MODULE – 4

Database Concepts, Web Designing



Notes

Inserting Images And Lists In A Web Page

- GIF file format is the best option for images with a few colors such as logos, pencil drawings etc. A lot of small animations are also available in the form of GIF files.
- PNG file format is the best option for images with transparency effects. PNG file format also supports lossless reduction in file size.

In any case the best way to judge the suitability of an image is your eyes. It is always a better idea to preview any web page before publishing (uploading it on the Internet) it.

25.2 INSERTING IMAGES IN A WEB PAGE

An image can be inserted in a web page by tag with with the following attributes:

| Attribute | Possible values of the attribute | Description |
|-----------|----------------------------------|---|
| SRC | URL of the image to be inserted | Specifies the URL (Location + FileName) of the image to be inserted in the page. The Location part of the URL is optional if the image lies in the same folder in which web page is stored. |
| ALIGN | Top, bottom, middle, left, right | Specifies the alignment of the image according to surrounding elements |
| BORDER | Number | Specifies the width (in pixels) of the border around the image. |
| HEIGHT | Number | Specifies the height (in pixels) of the image. |
| WIDTH | Number | Specifies the width (in pixels) of the image. |
| ALT | Text | Specifies the alternate text to be displayed if the image is not available or cannot be displayed. |

Out of these, SRC attribute is mandatory.

Example:

```
<IMG SRC = dream1.jpeg HEIGHT = 150 WIDTH = 200>
```

This statement will display an image dream1.jpg in the web page. Height and Width of the image are 150 pixels and 200 pixels respectively. The value of SRC attribute is just the file name. It means that the image exists in the same folder in which the web page is stored.

If the image is stored in the folder “M:\HTML\image” and the web page is stored in some other folder, then the element will be specified as follows:

```
<IMG SRC = “M:\HTML\images\dream1.jpeg” HEIGHT = 150 WIDTH = 200>
```

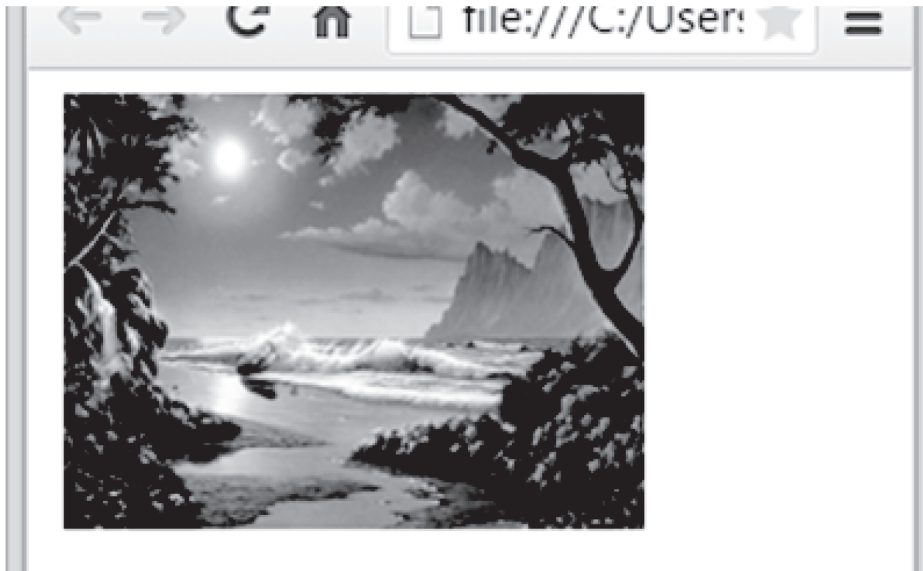

Fig. 25.1: The browser window

One tag inserts one image in the web page. By using multiple tags we can insert multiple images. Now let us see how various tags affect the appearance of an image.

Let us now see the effect of various attributes of tag.

The HEIGHT and WIDTH attributes are used to specify the height and width both (in pixels) of the image to be displayed. If the size (height and width) of an image is not as per the requirements of a web page, we specify the display size of the image by using HEIGHT and WIDTH attributes of the tag. If these attributes are not specified then the image will be displayed in original size.

BORDER tag is used to specify the size/width/thickness (in pixels) of the image border. If BORDER attribute is not specified then the images will be displayed without any border.

Sometimes, it may happen that the image to be displayed is not available or the image cannot be displayed in the browser. In such cases, the browser places a cross symbol (in place of the image) indicating that the image is not available or could not be displayed. The user does not get any clue about which image has to be displayed there. Using ALT attribute we can specify the alternate text to be displayed if the image is not available or cannot be displayed.



Notes

MODULE – 4

Database Concepts, Web
Designing

Inserting Images And Lists In A Web Page

An example of these attributes is given below. Carefully go through the HTML code and the corresponding web page.



Notes

```
1 <html>
2 <head>
3 <title>Image Attributes - I</title>
4 </head>
5 <body>
6 <center><h3>Tejas - Light Combat Aircraft built by HAL</h3></center>
7 <img src = "images\Tejas.jpg" height = 150 width = 150 ALT = Tejas>
8 <img src = "images\Tejas.jpg" height = 150 width = 250 BORDER = 2 ALT = Tejas>
9 <img src = "images\Tejs.jpg" height = 100 width = 100 BORDER = 4>
10 <img src = "images\Tejs.jpg" height = 100 width = 100 BORDER = 4 ALT = Tejas>
11
12 <P align = right>
13 <FONT FACE="Lucida Console", size = 2, color = red>
14 (Source: http://en.wikipedia.org/wiki/Hindustan\_Aeronautics) </FONT>
15 </body>
16 </html>
```

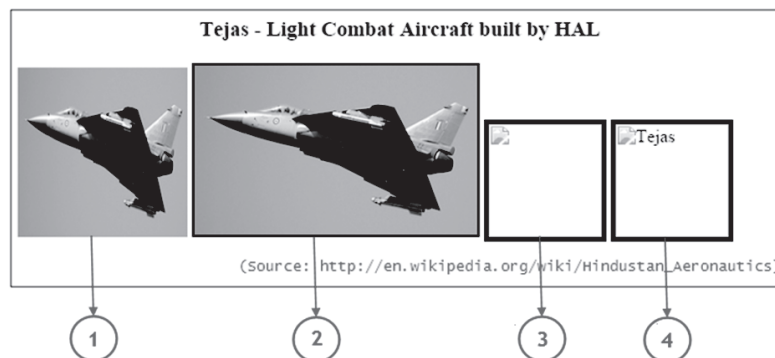

These four images, numbered 1,2,3, and 4, are due to statements numbered 7, 8, 9, and 10 respectively. You can easily observe the effect of various attributes.

Notice URL of the image in this example. The URL “images\Tejas.jpg” specifies that the image file, *Tejas.jpg*, lies in the sub-folder *images* of the current folder.

ALIGN Attribute

ALIGN attribute of tag specifies the alignment of the image according to surrounding elements. Different possible values of ALIGN attribute and their effects are given in the following table:

| value of ALIGN attribute | Effect |
|--------------------------|---|
| Left | Place the image at the left-most possible space in the window and wrap the other contents around the right hand side of that image. |
| Right | Place the image to the right-most possible space in the window. |
| Top | Aligns the top of the image with the top of the current line. |
| Middle | Aligns the middle of the image with the baseline of the current line. |
| Bottom | Aligns the bottom of the image with the baseline of the current line. |

An example of ALIGN attribute with different values is given below. Carefully go through the HTML code and the corresponding web page.

```

1 <html>
2 <head>
3 <title>Human Body</title>
4 </head>
5 <body>
6 <img src = "images\ear.jpg" width = 100 height = 100 border = 2 align = top>
7 Image (ear) is aligned with ALIGN = Top.
8 <P>
9 <img src = "images\tongue.jpg" width = 100 height = 100 border = 2 align = middle>
10 Image (tongue) is aligned with ALIGN = Middle.
11 <P>
12 <img src = "images\skin.jpg" width = 100 height = 100 border = 2 align = bottom>
13 Image (skin) is aligned with ALIGN = Bottom.
14 <P>
15 <img src = "images\nose.jpg" width = 100 height = 100 border = 2 align = left>
16 Image (nose) is aligned with ALIGN = Left.
17 <P>
18 <img src = "images\eye.jpg" width = 100 height = 100 border = 2 align = right>
19 Image (eye) is aligned with ALIGN = right.
20 <P>
21 </body>
22 </html>
    
```



Notes

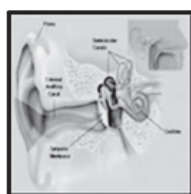

Image (ear) is aligned with ALIGN = Top.



Image (tongue) is aligned with ALIGN = Middle.

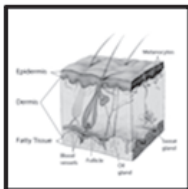

Image (skin) is aligned with ALIGN = Bottom.

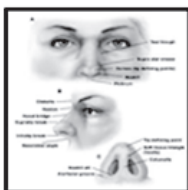

Image (nose) is aligned with ALIGN = Left.

Image (eye) is aligned with ALIGN = right.

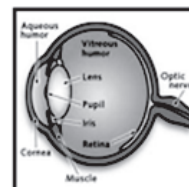

Fig. 25.2: Image tag with align attribute

MODULE – 4

Database Concepts, Web
Designing



Notes



INTEXT QUESTIONS 25.1

1. Fill in the blanks:
 - a. file format is the best option for images with lots of colors such as photographs.
 - b. file format is the best option for images with a few colors such as logos, pencil drawings etc.
 - c. file format is the best option for images with transparency effects.
 - d. tag is used to insert an image in a web page.
 - e. BORDER attribute of tag specifies the border width in
2. State whether the following statements are true or false:
 - a. tag has a corresponding tag.
 - b. Using ALIGN attribute of tag we can place an image in the center of the browser window.
 - c. ALIGN = TOP places an image at the top of the browser window.
 - d. Using SRC attribute of tag, we specify the URL of the image to be displayed.
 - e. BORDER attribute is used to specify border color of the image.

25.3 INSERTING LISTS IN A WEB PAGE

A list is a sequence of elements. Using HTML we can insert three types of lists in a web page. These lists are:

1. Unordered (Bulleted) Lists
2. Ordered (Numbered) Lists
3. Definition Lists

Unordered List

An unordered list is a bulleted list. An unordered list starts with and ends with . Items are inserted in the list using tag. An example of an unordered list is given below:



Notes

```

<UL>
<LI> Agricultural Aircraft </LI>
<LI>Fighter Aircrafts </LI>
<LI>Fighter Aircrafts </LI>
<LI>Helicopters</LI>
<LI>Engines </LI>
<LI>Trainer Aircrafts </LI>
<LI>Observation Aircrafts </LI>
<LI>Transport Aircrafts </LI>
</UL>
    
```

This is a part of an HTML document to show the unordered list only and will generate the following list:

- Agricultural Aircraft
- Fighter Aircrafts
- Fighter Aircrafts
- Helicopters
- Engines
- Trainer Aircrafts
- Observation Aircrafts
- Transport Aircrafts

Fig. 25.3: Unordered list

The shape of the bullets in a bulleted list can be changed by using the TYPE attribute of tag as shown in the following table:

| Value of TYPE attribute | Effect (Shape of the bullet) |
|-------------------------|------------------------------|
| DISC | ● (Filled Circle) |
| CIRCLE | ○ (Empty Circle) |
| SQUARE | ■ (Filled Square) |

MODULE – 4

Database Concepts, Web
Designing



Notes

Inserting Images And Lists In A Web Page

For example, if we use TYPE attribute with in the above code, it will have the following effects:

| <UL Type = DISC>(Default) | <UL Type = CIRCLE> | <UL Type = SQUARE> |
|---------------------------|-------------------------|-------------------------|
| ● Agricultural Aircraft | ○ Agricultural Aircraft | ■ Agricultural Aircraft |
| ● Fighter Aircrafts | ○ Fighter Aircrafts | ■ Fighter Aircrafts |
| ● Fighter Aircrafts | ○ Fighter Aircrafts | ■ Fighter Aircrafts |
| ● Helicopters | ○ Helicopters | ■ Helicopters |
| ● Engines | ○ Engines | ■ Engines |
| ● Trainer Aircrafts | ○ Trainer Aircrafts | ■ Trainer Aircrafts |
| ● Observation Aircrafts | ○ Observation Aircrafts | ■ Observation Aircrafts |
| ● Transport Aircrafts | ○ Transport Aircrafts | ■ Transport Aircrafts |

Ordered Lists

An ordered list is a list in which elements are given sequence numbers. Such lists are generally created when order of elements in the list is important. An ordered list is created using tag in the HTML code. Different items in the list are inserted using tag as in an unordered list. An example of an ordered list is given below:

| | | |
|--|---|--|
| <pre> Agricultural Aircraft Fighter Aircrafts Fighter Aircrafts Helicopters Engines Trainer Aircrafts Observation Aircrafts Transport Aircrafts </pre> | ➔ | <pre>1. Agricultural Aircraft 2. Fighter Aircrafts 3. Fighter Aircrafts 4. Helicopters 5. Engines 6. Trainer Aircrafts 7. Observation Aircrafts 8. Transport Aircrafts</pre> |
|--|---|--|

Using TYPE attribute of tag we can change the type of sequence numbers

| <OL Type = 1> | <OL Type = I> | <OL Type = i> |
|--------------------------|----------------------------|----------------------------|
| 1. Agricultural Aircraft | I. Agricultural Aircraft | i. Agricultural Aircraft |
| 2. Fighter Aircrafts | II. Fighter Aircrafts | ii. Fighter Aircrafts |
| 3. Fighter Aircrafts | III. Fighter Aircrafts | iii. Fighter Aircrafts |
| 4. Helicopters | IV. Helicopters | iv. Helicopters |
| 5. Engines | V. Engines | v. Engines |
| 6. Trainer Aircrafts | VI. Trainer Aircrafts | vi. Trainer Aircrafts |
| 7. Observation Aircrafts | VII. Observation Aircrafts | vii. Observation Aircrafts |
| 8. Transport Aircrafts | VIII. Transport Aircrafts | viii. Transport Aircrafts |
| <OL Type = A> | <OL Type = a> | |
| A. Agricultural Aircraft | a. Agricultural Aircraft | |
| B. Fighter Aircrafts | b. Fighter Aircrafts | |
| C. Fighter Aircrafts | c. Fighter Aircrafts | |
| D. Helicopters | d. Helicopters | |
| E. Engines | e. Engines | |
| F. Trainer Aircrafts | f. Trainer Aircrafts | |
| G. Observation Aircrafts | g. Observation Aircrafts | |
| H. Transport Aircrafts | h. Transport Aircrafts | |



Notes

We can also start the ordered list with a number other than 1 using START attribute of tag. START attribute can take any integer value with which we want to start the list. Two examples of lists with START attributes are given below.

| <OL START = 4> | <OL Type = A START = 6> |
|---------------------------|--------------------------|
| 4. Agricultural Aircraft | F. Agricultural Aircraft |
| 5. Fighter Aircrafts | G. Fighter Aircrafts |
| 6. Fighter Aircrafts | H. Fighter Aircrafts |
| 7. Helicopters | I. Helicopters |
| 8. Engines | J. Engines |
| 9. Trainer Aircrafts | K. Trainer Aircrafts |
| 10. Observation Aircrafts | L. Observation Aircrafts |
| 11. Transport Aircrafts | M. Transport Aircrafts |

Notice that START takes an integer value irrespective of the TYPE attribute.



Notes

Definition List

Definition Lists are used when some terms have to be defined. A definition list is created using <DL> tag. A definition list contains terms to be defined and their definitions. Terms to be defined are specified using <DT> tag and the corresponding definitions are specified using <DD> tag.

An example of a definition list to define some Aviation related terms is given below:

```
<DL><CENTER><B><U>Some Aviation Related Terms</U></B></CENTER>
<DT>Circumnavigation</DT>
<DD>traveling around something (by ship or plane); "Magellan's
circumnavigation of the earth proved that it is a globe"</DD>
<DT>Airliner</DT>
<DD>a commercial airplane that carries passengers</DD>
<DT>Amphibian</DT>
<DD>an airplane designed to take off and land on water</DD>
<DT>Biplane</DT>
<DD>old fashioned airplane; has two wings one above the other</DD>
</DL>
```



Some Aviation Related Terms

Circumnavigation
traveling around something (by ship or plane): "Magellan's circumnavigation of the earth proved that it is a globe"

Airliner
a commercial airplane that carries passengers

Amphibian
an airplane designed to take off and land on water

Biplane
old fashioned airplane; has two wings one above the other

Fig. 25.4: Definition list

Nesting of lists

In HTML we can nest lists into one another upto any level. An example of a nested list is given below:

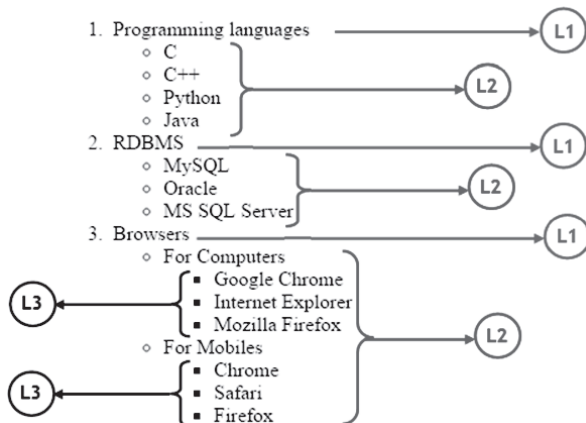

This list is a numbered list (items marked *L1*) in which each item contains a bulleted (items marked *L2*). The third item of the ordered list contains an unordered list in which each item again contains an unordered list (items marked *L1*).

To write the HTML code for this list, we start with `` for the numbered list. The first item of this list contains some text (Programming Languages) and an unordered list. Therefore, the code goes as follows:



Notes

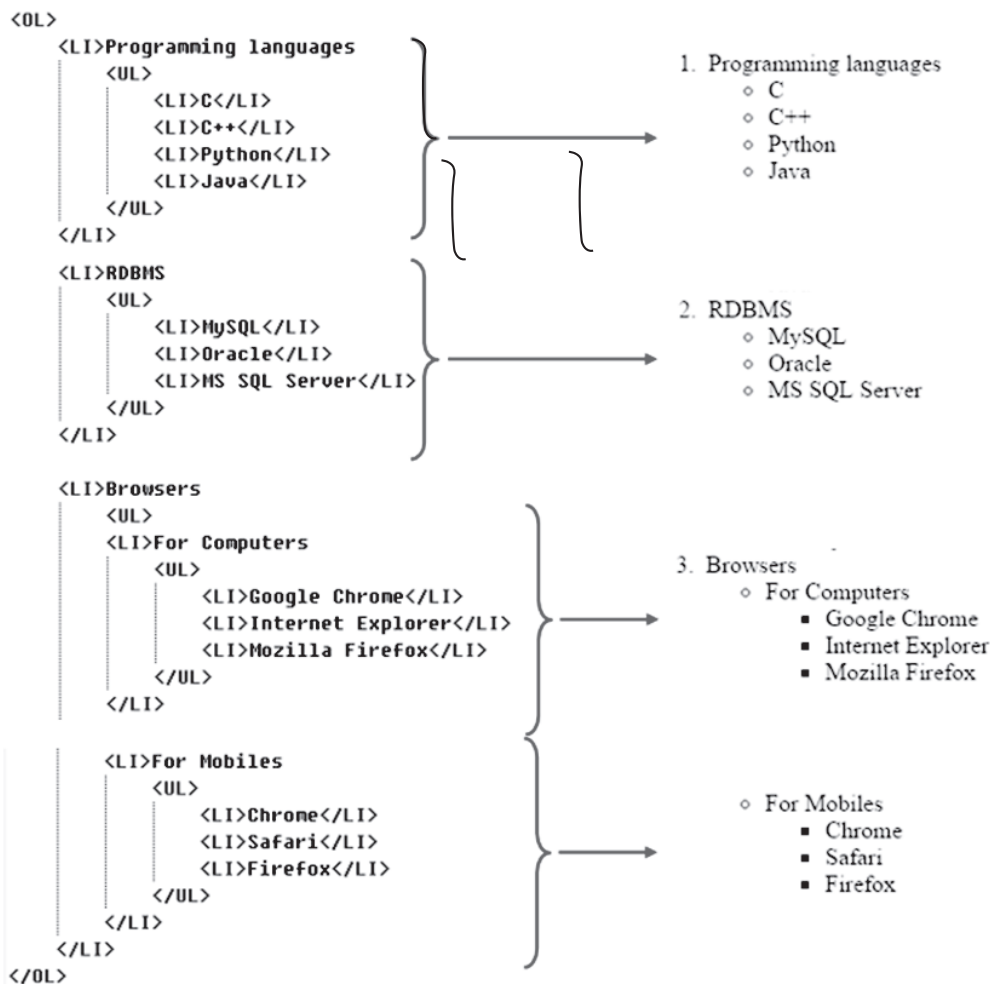

Like this we can nest any list (Unordered, Ordered, Definition) in any other (Unordered, Ordered, Definition).

MODULE – 4

Database Concepts, Web
Designing



Notes

Inserting Images And Lists In A Web Page

Following is an example which combines the concepts of nested lists and images. The code is followed by the corresponding web page.

```
1 <html>
2 <head>
3 <title>HAL Products</title>
4 </head>
5 <body>
6 Partial List of In-house developed/under development
7 products of Hindustan Aeronautics Limited
8 <OL>
9
10 <LI><B>Agricultural Aircraft</B>
11 <IMG SRC = "images\hal_basant.jpg" height = 100 width = 150 align = middle>
12 <UL>
13 <LI>HA-31 Basant</LI>
14 </UL>
15 </LI>
16
17 <P>
18 <LI><B>Fighter Aircrafts</B>
19 <IMG src = images\Tejas.jpg height = 100 width = 150 align = middle>
20 <UL>
21 <LI>HAL Tejas</LI>
22 <LI>HF-24 Marut</LI>
23 <LI>Su-30MKI</LI>
24 <LI>FGFA</LI>
25 <LI>AMCA</LI>
26 </UL>
27 </LI>
28
29 <P>
30 <LI>Helicopters
31 <IMG src = images\Dhruv.jpg height = 100 width = 150 align = middle>
32 <UL>
33 <LI>Dhruv</LI>
34 <LI>Light Combat Helicopter</LI>
35 <LI>Light Observation Helicopter</LI>
36 <LI>Indian multi-role Helicopter</LI>
37 <LI>Rudra</LI>
38 </UL>
39 </LI>
40
41 <P>
42 <LI>Trainer Aircrafts
43 <IMG src = images\Kiran.jpg height = 100 width = 150 align = middle>
44 <UL>
45 <LI>HT-2</LI>
46 <LI>HT-32 Deepak</LI>
47 <LI>HJT-16 Kiran</LI>
48 <LI>HTT-34</LI>
49 <LI>HJT-36 Sitara</LI>
50 </UL>
51 </LI>
52 </OL>
53 </body>
54 </html>
```



Notes

Partial List of In-house developed/under development products of Hindustan Aeronautics Limited

1. Agricultural Aircraft
 - ◊ HA-31 Basant
2. Fighter Aircrafts
 - ◊ HAL Tejas
 - ◊ HF-24 Marut
 - ◊ Su-30MKI
 - ◊ FGFA
 - ◊ AMCA
3. Helicopters
 - ◊ Dhruv
 - ◊ Light Combat Helicopter
 - ◊ Light Observation Helicopter
 - ◊ Indian multi-role Helicopter
 - ◊ Rudra
4. Trainer Aircrafts
 - ◊ HT-2
 - ◊ HT-32 Deepak
 - ◊ HJT-16 Kiran
 - ◊ HTT-34
 - ◊ HJT-36 Sitara

Fig. 25.5: Nested list with images



INTEXT QUESTIONS 25.2

1. Fill in the blanks:
 - a. In an _____ each item is preceded by a sequence number.
 - b. _____ tag is used to create an unordered list.
 - c. _____ tag is used to insert item in an ordered or unordered list.
 - d. By default an ordered list starts with sequence number _____ .
 - e. Using _____ attribute we can change the bullet types in an unordered list.

MODULE – 4

Database Concepts, Web
Designing



Notes

Inserting Images And Lists In A Web Page

2. State whether the following statements are true or false:
 - a. <DT> tag is used to start a definition list.
 - b. TYPE attribute can be used with as well as tag.
 - c. We can nest an ordered list in an unordered list.
 - d. Ordered list cannot be nested in a definition list.
 - e. START attribute is used with tag.



WHAT YOU HAVE LEARNT

1. Digital images exist in many different formats.
2. JPG, GIF, and PNG formats of images are generally used on web pages.
3. tag along with SRC attribute is used to insert images in a web page.
4. SRC, ALIGN, BORDER, HEIGHT, WIDTH, and ALT are the attributes of tag.
5. Different types of lists can be inserted in a web page. The types of lists are: Unordered List, Ordered List, and Definition List.
6. Unordered lists are created using tag.
7. Ordered lists are created using tag.
8. tag is used to insert items in ordered and unordered lists.
9. Attributes of tag are TYPE and START.
10. Attributes of tag is TYPE.
11. Definition lists are created using <DL> tag.
12. In a definition list Definition Term is inserted using <DT> tag and Definition Description is inserted using <DD> tag.
13. Any type of list can be nested in any other type of list.



TERMINAL EXERCISE

1. Name any five digital file formats.
2. When are the following file formats suitable:
JPG, GIF, PNG.

3. Which tag is used to insert images in a web page? How do we specify which image is to be inserted?
4. How is it possible to change the display size of the image without altering the original image?
5. What happens if the image to be displayed in the web page is not available? What is the use of ALT attribute in such a case?
6. What are the different possible values of ALIGN attribute of tag? What are their effects?
7. What are the different types of lists that can be inserted in a web page?
8. Write an HTML code to create the following lists:

Streams

1. Non Medical science
2. Medical science
3. Commerece
4. Humanities

Subjects for Non-Medical Science

- English
- Computer Science
- Physics
- Chemistry
- Maths



Notes



ANSWERS TO INTEXT QUESTIONS

25.1

1. a) JPEG b) GIF c) PNG d) e) Pixels
2. a) False b) False c) True d) True e) False

25.2

1. a) Ordered List b) c) d) 1 e) TYPE
2. a) False b) True c) True d) False e) True